

# Bases de signalisation en béton

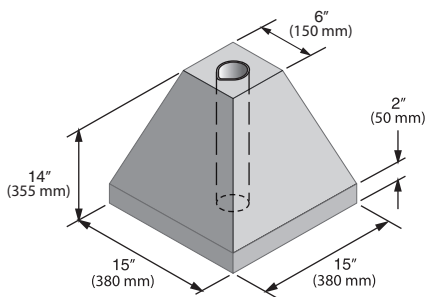

Pour tuyau  
de 2" (50 mm)

Poids  
115 lb (52 kg)

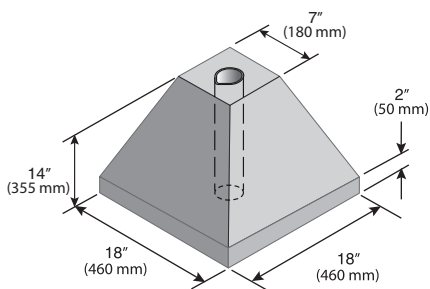

Pour tuyau  
de 2" (50 mm)

Poids  
200 lb (91 kg)



Avec poteau en «U»

Poids  
115 lb (52 kg)

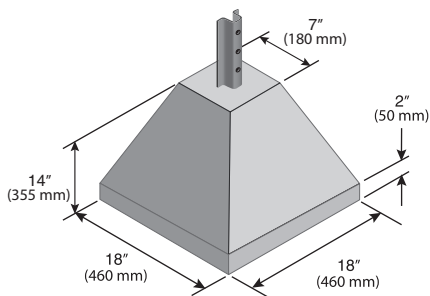

Avec poteau en «U»

Poids  
200 lb (91 kg)

# Bases de signalisation en béton

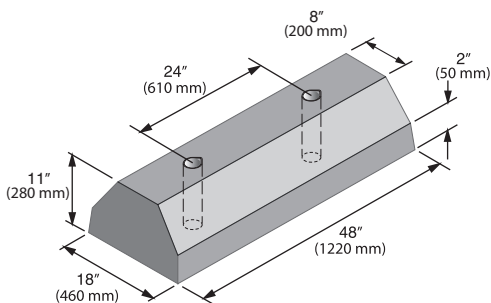

Pour tuyau  
de 2" (50 mm)

Poids  
575 lb (260 kg)

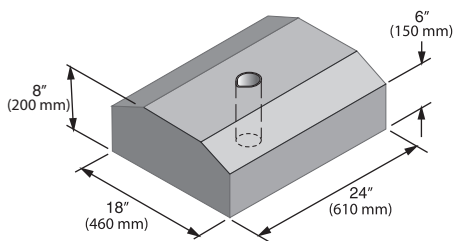

Pour tuyau  
de 2" (50 mm)

Poids  
285 lb (130 kg)

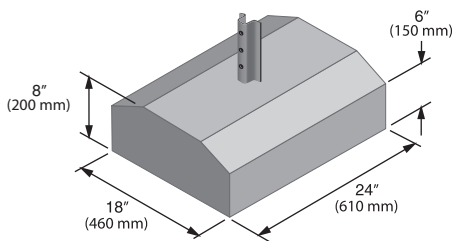

Avec poteau «U»

Poids  
285 lb (130 kg)

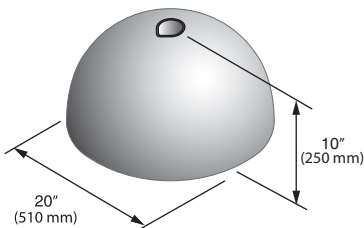

Avec poteau «U»

Poids  
330 lb (150 kg)